

Interleaved Boost Converter with a Voltage Multiplier for PV Module Using Grid Connected Load in Rural Areas

K A Yamuna

Dept. of Electrical and Electronics, Rajiv Gandhi Institute of Technology, Pampady, Kottayam, Kerala, India

ABSTRACT: In the existing system having step-up converters, such as the boost converter and fly back converter, it is not possible to achieve a high step-up conversion with high efficiency because of the resistances of elements or leakage inductance. Conventional step-up converters with a single switch are un-suitable for high-power applications which gives an input large current ripple, which increases conduction losses. Thus numerous interleaved structures and some asymmetrical interleaved structures are extensively used. The step up converter with voltage multiplier is an asymmetrical interleaved converter for a high step-up gain, which is suitable for high-power application. The voltage multiplier module is composed of a conventional boost converter and coupled inductors. Through this voltage multiplier module, a high step-up gain is obtained without operating at an extreme duty ratio. For achieving a high voltage conversion ratio, an extra conventional boost converter is introduced. The two-phase configuration reduces the current stress through each power switch and input current ripple, which decreases the conduction losses of MOSFETs. Since the energy stored in leakage inductances is recycled to the output terminal, efficiency can be improved.

KEYWORD: Photo voltaic system, boost converter, voltage multiplier.

I. INTRODUCTION

Regardless of the intermittency of sunlight, solar energy is widely available and is free. Recently, photovoltaic system is recognized to be in the forefront in renewable electric power generation [1]. It can generate direct current electricity without an environmental impact and contamination when exposed to solar radiation. Being a semiconductor device, the PV system is static, quiet, free of moving parts, and has little operation and maintenance costs. PV module represents the fundamental power conversion unit of a PV generator system. The output characteristics of a PV module depend on the solar insolation, the cell temperature and the output voltage of the PV module. Since PV module has non linear characteristics, it is necessary to model it for the design and simulation of maximum power point tracking (MPPT) for PV system applications.

DC to DC converter is a device that converts low value of dc input voltage to another dc output voltage. Typically the output produced is at a different voltage level than the input. Conventional step-up converters, such as the boost converter and flyback converter, cannot achieve a high step-up conversion with high efficiency because of the resistances of elements or leakage inductance [2]. So a modified boost fly back converter, and many converters that use the coupled inductor for a considerably high voltage conversion ratio were developed [3].

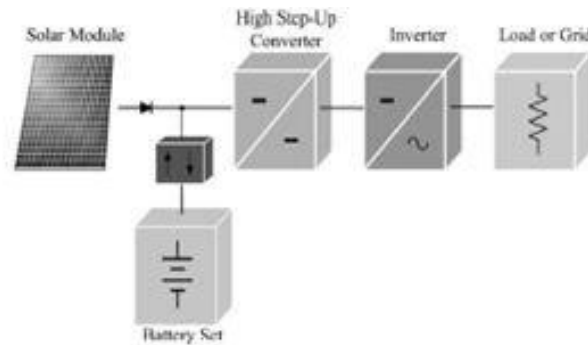

Fig. 1. Typical pv system with grid connected load

Conventional step-up converters with a single switch are unsuitable for high power applications given an input large current ripple, which increases conduction losses. Thus, numerous interleaved structures and some asymmetrical interleaved structures are extensively used. Due to several reasons such as parasitic components, the requirement of a high duty cycle, conventional DC-DC converters can not achieve a high voltage gain. Many topologies have been proposed to overcome these disadvantages with high voltage gain without the use of high duty cycles. Converters with transformers provide high voltage gain a low voltage stress on the active switch, and a high efficiency without the increase of high duty ratio. The transformer can be replaced with coupled inductors to reduce the conduction or core losses in the system.

A voltage multiplier is an electrical circuit that converts power from low voltage to a higher DC voltage. Interleaved structure is employed in the input side to reduce the input current ripple and improve the power level. The voltage multiplier circuit is adopted in the output side to achieve a high step-up voltage gain and simplify the circuit structure. The voltage multiplier circuit is composed of capacitors, diodes, and two coupled inductors, which can extend the voltage gain and minimize the current ripple without extreme duty cycle. Switch voltage stress is reduced as the turns ratio of the coupled inductors increases, which makes low-voltage rated MOSFETs available to improve the circuit performance. The diode reverse recovery problem can be alleviated by the leakage inductance of the coupled inductors, which reduces the reverse recovery losses. The use of power Metal Oxide Semiconductor Field Effect Transistor (MOSFETs) and diodes makes the circuit working at higher frequencies of range 40 kHz, resulting in a reduced value of the capacitance required in the capacitor diode voltage multiplier connecting boost converter. The high step up DC-DC converter with coupled inductor and voltage multiplier is discussed in this report. The fig 1.1 shows a typical photovoltaic system connecting to dc-dc converter, inverter and load [1].

II. OPERATING PRINCIPLE DESCRIPTION

The step up converter is a non-isolated topology for boosting low voltage input to high voltage output. The input current are usually continuous in nature and is supplied to the load by either the conduction of diodes or capacitors. The boost converter with voltage multiplier by means of coupled inductor insertion increases the output voltage, hence the voltage gain and efficiency, with low value of duty cycle. The output voltage across the load is the sum of the voltage from boost converter and the voltage across the voltage multiplier capacitors. The required duty cycle can be obtained by adjusting the voltage multiplier, which increases the output voltage. An asymmetrical interleaved high step-up converter that combines the advantages of both conventional boost converters and voltage multiplier is discussed is shown in fig 1.(a). The voltage gain can be extended by voltage lift capacitor and voltage multiplier connected in the circuit. The voltage lift capacitor connected to the boost converter increases the output voltage. The converter works in continuous conduction mode of operation. The power is delivered to the load during both ON and OFF states. The active clamp circuits are in builds on the converter for high voltage conversion.

The converter can be described with six modes of operation. The fig 1.(b) shows the equivalent circuit of the converter showing the leakage inductance and mutual inductances of the circuit. S1 and S2 denote the power switches, Cb is the voltage lift capacitor, and n is defined as a turns ratio N_s / N_p .

Mode 1: Initially $t=t_0$, the switches S_1 and S_2 are both turned ON and all diodes are reverse-biased. The input voltage V_{in} charges the magnetizing inductors L_{m1} and L_{m2} linearly. Also the charges leakage inductors L_{k1} and L_{k2} .

Mode 2: At instant $t=t_1$, the switch S_2 is switched OFF, diodes D_2 and D_4 become forward biased. The energy that magnetizing inductor L_{m2} has stored is released to the secondary side of coupled inductor charging the output filter capacitor C_3 . The input voltage source, magnetizing inductor L_{m2} , leakage inductor L_{k2} , and voltage lift capacitor C_b transfer energy to the output filter capacitor C_1 via diode D_2 , increases the voltage on C_1 .

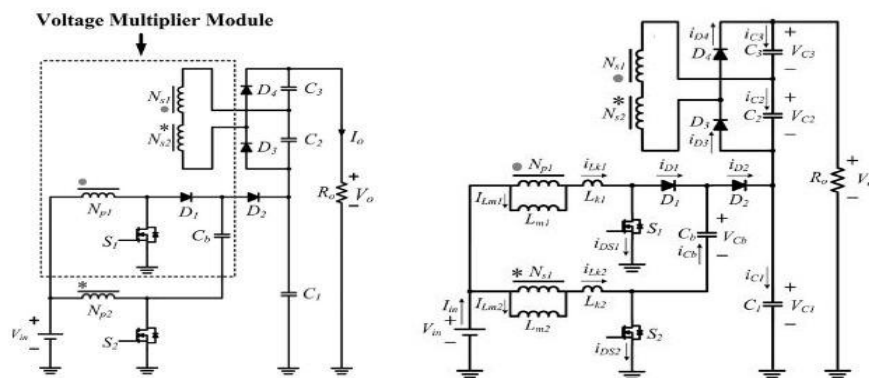

Fig. 2. (a)Proposed converter with voltage multiplier module and (b)Equivalent circuit of proposed converter

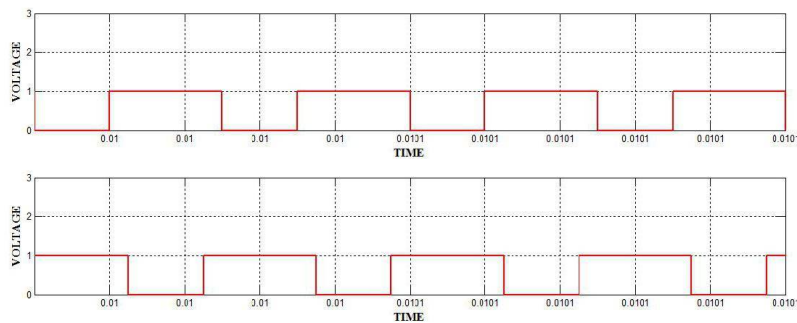

Fig. 3. (a)Triggering pulses of proposed converter

Mode 3: At instant $t=t_2$, the diode D_2 turn OFF because the total energy stored in the leakage inductor L_{k2} is completely released to the output filter capacitor C_1 . Magnetizing inductor L_{m2} release energy to the secondary side charging the output filter capacitor C_3 through diode D_4 .

Mode 4: At instant $t=t_3$, the switch S_2 is switched ON and all the diodes get reverse biased.

Mode 5: At instant $t=t_4$, the switch S_1 is turned OFF, which turns ON diodes D_1 and D_3 . The energy stored in magnetizing inductor L_{m1} is transferred to the secondary side charging the output filter capacitor C_2 . The input voltage source and magnetizing inductor L_{m1} transfer energy to voltage-lift capacitor C_b via diode D_1 , which stores extra energy in C_b .

Mode 6: At $t=t_5$, diode D_1 become reverse biased because the total energy of leakage inductor L_{k1} has been completely released to voltage-lift capacitor C_b . Magnetizing inductor L_{m1} transfers energy to the secondary side charging the output filter capacitor C_2 via diode D_3 until t_0 .

Some assumptions are made for the analysis of the con-verter: 1. All of the components are ideal 2. Leakage inductors Lk1 and Lk2 are neglected [4]. 3. Voltage Vcb, Vc1, Vc2, and Vc3 are considered to be constant because of their large values.

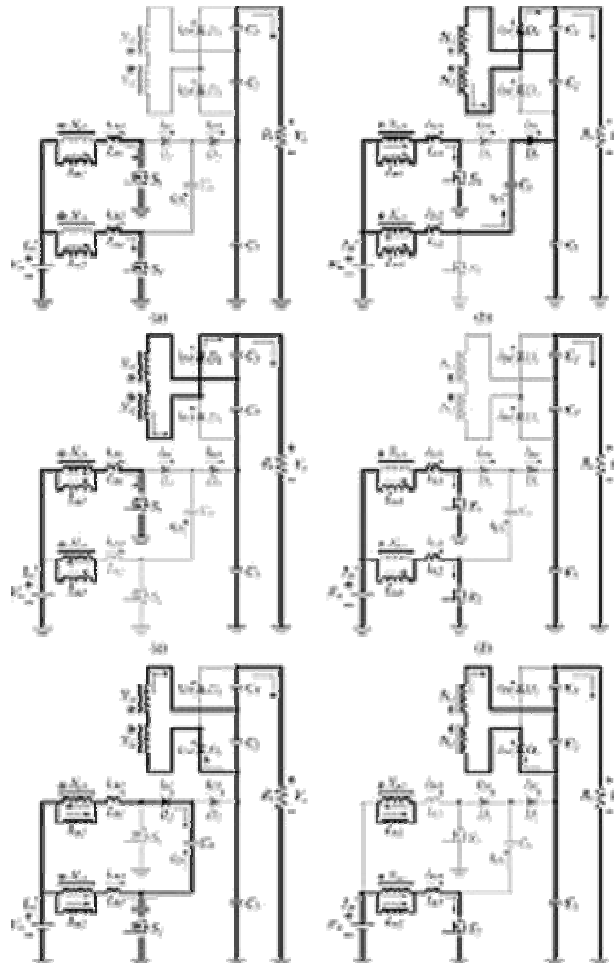

Fig. 4. mode of operation of proposed converter. (a) Mode1 (b) Mode2 (c) Mode3 (d) Mode4 (e) Mode5 (f) Mode6

Figures 4. shows the various modes of operation of converter with voltage multiplier [5]. The fig 3.(a) shows a triggering pulses of the converter.

A. SIMULATION OF HIGH BOOT CONVERTER WITH VOLTAGE MULTIPLIER

The high gain high step up converter with voltage mul-tiplier is simulated on MATLAB software environment with photovoltaic system. The simulation was done with an input of 30-35 V supply to obtain an output of 300-330 V with com-bination of boost converter with voltage multiplier. Fig 6.and shows the simulation diagram of the converter. The inter-leaved boost converter topology is designed for minimising the switching losses and to improve the efficiency. The advantages of interleaved boost converters are to reduce current ripple and increases life of PV module. The capacitors C2 and C3 are designed for 220microF and C1 for 470microF. The frequency is adjusted to 40 kHz by means of a pulse generator to obtain a gate pulse for both the MOSFET switches. In the simulation of boost converter with voltage multiplier the voltage across load VL, voltage across switch VS, voltages across capacitors Vc1, Vc2 and Vc3 are obtained. The Table 1 shows the specification required in the simulation of the proposed converter design in MATLAB software. The design consideration of the high boost converter integration with voltage multiplier includes

components selection and coupled inductor design [1]s. Due to the performance of high step up gain the turns ratio are set as 1:1. The boost converter with voltage multiplier can be efficiently implemented for step up conversion without extreme duty cycle [6].

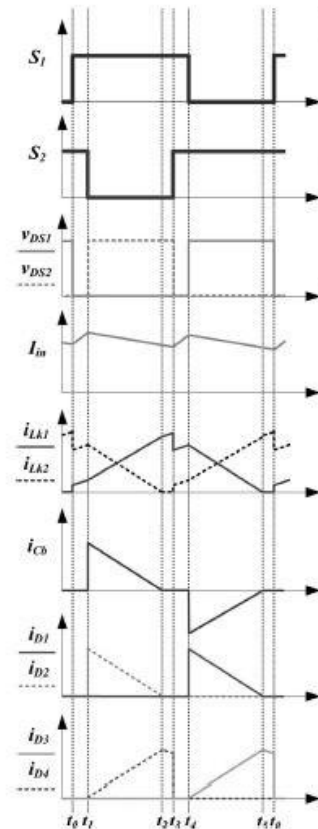

Fig. 5. Waveform of proposed converter

TABLE I

CONVERTER COMPONENTS AND PARAMETERS

Parameters	Symbols	Specification
Input voltage	Vin	30v
Output voltage	Vout	300v
Turns Ratio	n(Ns/Np)	1
Switching frequency	fs	40khz
Load	R	200W
Capacitor	c1	470microF
Capacitor	c2	220microF
Capacitor	c3	220microF
Diode	D1,D2,D3	IN4007
Mosfet	S	IRFP250

Fig. 6. Simulation input Result

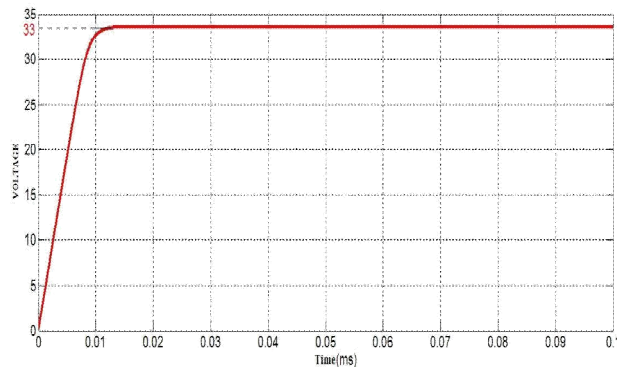
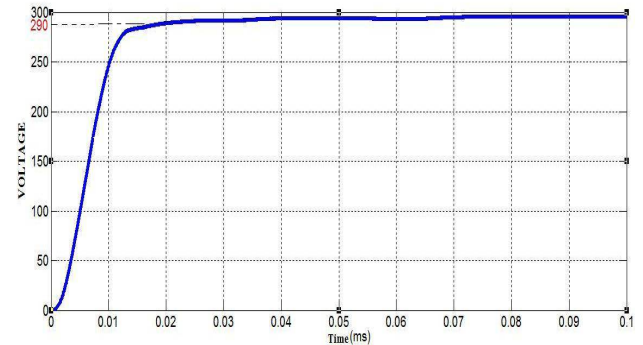

Fig. 7. Simulation output Result



III.CONCLUSION

A high step up converter with a voltage multiplier module has presented the topological principles, steady state analysis, and simulation results. This converter has been successfully implemented in an efficiently high step-up conversion without an extreme duty ratio and a number of turns ratios through the voltage multiplier module and voltage clamp feature. The interleaved PWM scheme reduces the currents that pass through each power switch and constrained the input current ripple by approximately 6 percent. The voltage stresses over the power switches are restricted and are much lower than the output voltage (380 V). These switches, conducted to low voltage rated and low on-state resistance MOSFET, can be selected. Furthermore, the full-load efficiency is 96.1 percent at Power=1000 W, and the highest efficiency is 96.8 percent at Power=400 W. Thus, the converter is suitable for PV systems or other renewable energy applications that need high step-up high-power energy conversion.

REFERENCES

- [1]K. C. Tseng, C. C. Huang, and W. Y. Shih, "A high step-up converter with a voltage multiplier module for a photovoltaic system," IEEE Transactions on Power Electronics, vol. 28, no. 6, pp. 3047–3057, June 2013.
- [2]K. C. Tseng and T. J. Liang, "Novel high-efficiency step-up converter," IEE Proceedings - Electric Power Applications, vol. 151, no. 2, pp. 182–190, Mar 2004.
- [3]H. Ghoddami and A. Yazdani, "A single-stage three-phase photovoltaic system with enhanced maximum power point tracking capability and increased power rating," IEEE Transactions on Power Delivery, vol. 26, no. 2, pp. 1017–1029, April 2011.
- [4]W. Li, Y. Zhao, J. Wu, and X. He, "Interleaved high step-up converter with winding-cross-coupled inductors and voltage multiplier cells," IEEE Transactions on Power Electronics, vol. 27, no. 1, pp. 133–143, Jan 2012.
- [5]C. M. Lai, C. T. Pan, and M. C. Cheng, "High-efficiency modular high step-up interleaved boost converter for dc-microgrid applications," IEEE Transactions on Industry Applications, vol. 48, no. 1, pp. 161–171, Jan 2012.
- [6]J. M. Carrasco, L. G. Franquelo, J. T. Bialasiewicz, E. Galvan, R. C. PortilloGuisado, M. A. M. Prats, J. I. Leon, and N. Moreno-Alfonso, "Power-electronic systems for the grid integration of renewable energy sources: A survey," IEEE Transactions on Industrial Electronics, vol. 53, no. 4, pp. 1002–1016, June 2006.